

Submittal

**4.0 Ton
Convertible Air Handler
A4AH4E48B1C30A**

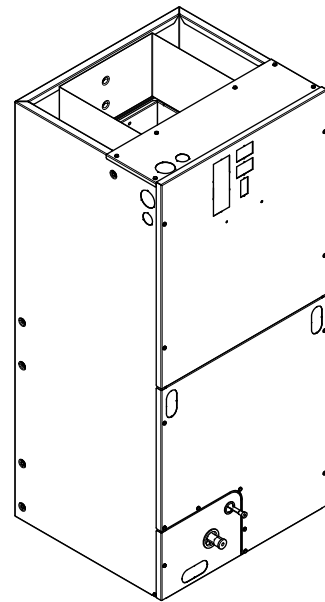

Outline Drawing

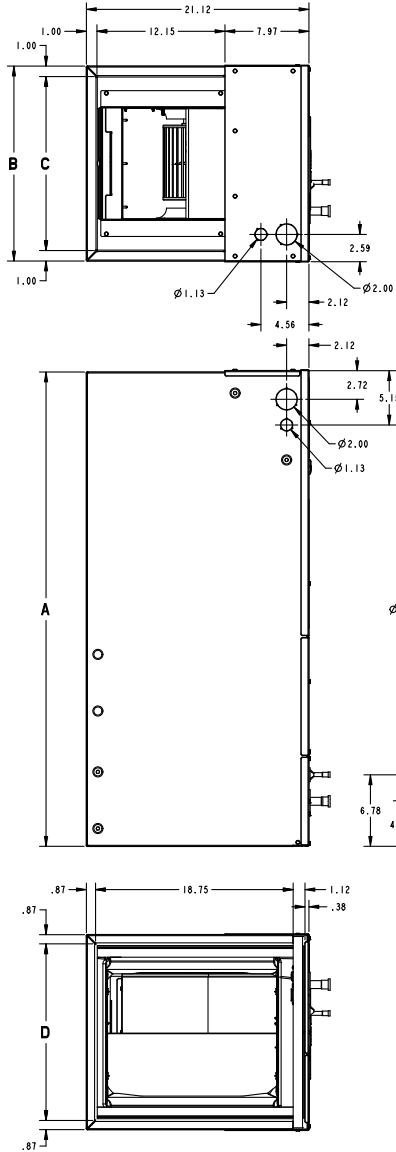

MINIMUM UNIT CLEARANCE TABLE	
	SERVICE CLEARANCE (RECOMMENDED)
SIDES	2"
FRONT	21"
BACK	0"
INLET DUCT	1"
OUTLET DUCT	N/A

NOTE: THIS UNIT IS APPROVED FOR INSTALLATION CLEARANCES TO COMBUSTIBLE MATERIAL AS STATED ON THE UNIT RATING NAMEPLATE

NOTE: ALL DIMENSIONS ARE REFERENCE DIMENSIONS

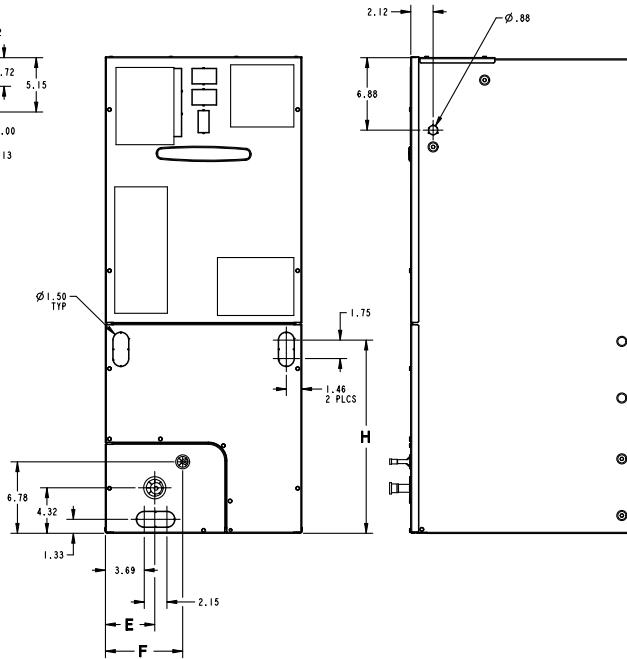

PRODUCT DIMENSIONS

Air Handler Model	A	B	C	D	E	F	H	Flow Control	Gas Line Braze
A4AH4E48B1C30A	57.40	23.50	21.50	21.75	4.68	9.66	27.19	TXV	7/8

All dimensions are in inches

Product Specifications

MODEL	A4AH4E48B1C30A
RATED VOLTS/PH/HZ	208-230/1/60
RATINGS^(a)	See O.D. Specifications
INDOOR COIL — Type	Plate Fin
Rows — F.P.I.	3 - 16
Face Area (sq. ft.)	7.9
Tube Size (in.)	3/8
Refrigerant Control	TXV
Drain Conn. Size (in.) ^(b)	3/4 NPT
DUCT CONNECTIONS	See Outline Drawing
INDOOR FAN — Type	Centrifugal
Diameter-Width (In.)	11 X 11
No. Used	1
Drive - No. Speeds	Direct - 5 ^(c)
CFM vs. in. w.g.	See Fan Performance Table
No. Motors — H.P.	1 - 3/4
Motor Speed R.P.M.	1050
Volts/Ph/Hz	208-230/1/60

F.L. Amps	6.0
FILTER	
Filter Furnished? ^(d)	No
REFRIGERANT	R-410A
Ref. Line Connections	Brazed
Coupling or Conn. Size — in. Gas	7/8
Coupling or Conn. Size — in. Liq.	3/8
DIMENSIONS	H x W x D
Crated (In.)	57-1/8 x 27-1/2 x 25-1/2
Uncrated	55-3/4 x 23-1/2 x 21-1/8
WEIGHT	
Shipping (Lbs.) / Net (Lbs.)	185/174

^(a) These Air Handlers are A.H.R.I certified with various Split System Air Conditioners and Heat Pumps (AHRI STANDARD 210/240). Refer to the Split System Outdoor Unit Product Data Guides for performance data.

^(b) 3/4" Male Plastic Pipe (Ref: ASTM 1785-76)

^(c) ECM Motor

^(d) Remote filter required.

Minimum Airflow CFM

A4AH4E48B1C30A		
Heater	Minimum Heat Speed Tap	
	With Heat Pump	Without Heat Pump
BAYHTR1504BRK, BAYHTR1504LUG, BAYHTR1505BRK, BAYHTR1505LUG, BAYHTR1508BRK, BAYHTR1508LUG, BAYHTR1510BRK, BAYHTR1510LUG, BAYHTR3510LUG	Med-Low	Med-Low
BAYHTR1517BRK, BAYHTR3517LUG	Med	Med
BAYHTR1523BRK, BAYHTR1525BRK	Med-High	Med

Heater Pressure Drop Table

Airflow CFM	Number of Racks				Heater Racks	
	1	2	3	4	Heater Model	No. of Racks
	Air Pressure Drop — Inches W.G.					
1800	0.02	0.04	0.06	0.14	BAYHTR1504	1
1700	0.02	0.04	0.06	0.14	BAYHTR1505	1
1600	0.02	0.04	0.06	0.13	BAYHTR1508	2
1500	0.02	0.04	0.06	0.12	BAYHTR1510	2
1400	0.02	0.04	0.06	0.12	BAYHTR1517	3
1300	0.02	0.04	0.05	0.11	BAYHTR3510	3
1200	0.01	0.04	0.05	0.10	BAYHTR3517	3
1100	0.01	0.03	0.05	0.09	BAYHTR3515	3
1000	0.01	0.03	0.04	0.09	BAYHTR1523	4
900	0.01	0.03	0.04	0.08	BAYHTR1525	4
800	0.01	0.03				
700	0.01	0.02				
600	0.01	0.02				

Performance and Electrical Data

1. See Product Data or Air Handler nameplate for approved combinations of Air Handlers and Heaters.
2. Heater model numbers may have additional suffix digits.

Table 1. Air Flow Performance

A4AH4E48B1C30A					
EXTERNAL STATIC (in w.g)	AIRFLOW				
	Speed Taps: 208 – 230 VOLTS				
	High	Med-High	Med †	Med-Low	Low
0.1	2040	1874	1658	1512	1373
0.2	2008	1846	1622	1476	1333
0.3	1975	1816	1585	1438	1289
0.4	1942	1785	1546	1395	1240
0.5	1909	1751	1506	1349	1187
0.6	1875	1716	1463	1300	1129
0.7	1841	1678	1418	1246	1067

1. Values are with wet coil, no filter, and no heaters
 2. CFM Correction for dry coil = Add 3%
 3. † = Factory Setting
 4. In downflow applications, airflow must not exceed 1800 cfm due to condensate blowoff.
 5. Low = Tap 1, Med-Low = Tap 2, Med = Tap 3, Med-High = Tap 4, High = Tap 5

Table 2. Electrical Data

A4AH4E48B1C30A											
Heater Model No.	No. of Circuits/ Phases	240 Volt					208 Volt				
		Capacity		Heater Amps per Circuit	Minimum Circuit Ampacity	Maximum Overload Protec- tion	Capacity		Heater Amps per Circuit	Mini- mum Circuit Ampaci- ty	Maximum Overload Protection
		kW	BTUH				kW	BTUH			
No Heater				6.0 *	8	15			6.0 *	8	15
BAYHTR1504BRK BAYHTR1504LUG	1/1	3.8	13100	16.0	28	30	2.9	9800	13.8	25	25
BAYHTR1505BRK BAYHTR1505LUG	1/1	4.8	16400	20.0	33	35	3.6	12300	17.3	29	30
BAYHTR1508BRK BAYHTR1508LUG	1/1	7.7	26200	32.0	48	50	5.8	19700	27.7	42	45
BAYHTR1510BRK BAYHTR1510LUG	1/1	9.6	32800	40.0	58	60	7.2	24600	34.6	51	60
BAYHTR1517BRK- Circuit 1 ^(a)	2/1	9.6	32800	40.0	58	60	7.2	24600	34.6	51	60
BAYHTR1517BRK- Circuit 2		4.8	16400	20.0	25	25	3.6	12300	17.3	22	25
BAYHTR1523BRK- Circuit 1	2/1	9.6	32800	40.0	58	60	7.2	24600	34.6	51	60
BAYHTR1523BRK- Circuit 2		9.6	32800	40.0	50	50	7.2	24600	34.6	43	45

Performance and Electrical Data

Table 2. Electrical Data (continued)

A4AH4E48B1C30A											
BAYHTR1525BRK-Circuit 1	4/1	6.0	20500	25.0	39	40	4.5	15400	21.6	35	35
BAYHTR1525BRK-Circuit 2		6.0	20500	25.0	31	35	4.5	15400	21.6	27	30
BAYHTR1525BRK-Circuit 3		6.0	20500	25.0	31	35	4.5	15400	21.6	27	30
BAYHTR1525BRK-Circuit 4		6.0	20500	25.0	31	35	4.5	15400	21.6	27	30
BAYHTR3510LUG	1/3	9.6	32800	23.1	36	40	7.2	24600	20.0	32	35
BAYHTR3517LUG	1/3	14.4	49100	34.6	50	50	10.8	36900	30.0	44	45
BAYHTR1517BRK with single circuit power source kit BAYSPEKT201A	1/1	14.4	49100	60.0	83	90	10.8	36900	51.9	73	80
BAYHTR1523BRK with single circuit power source kit BAYSPEKT201A	1/1	19.2	65500	80.0	108	110	14.4	49100	69.2	94	100
* = Motor Amps											

(a) MCA and MOP for circuit 1 contains the motor amps.

Features and Benefits

- Galvanized metal cabinet with captured foil face insulation
- 2% or less air leakage
- R-4.2 Insulating Value
- Multi-Position UP/Down Flow, Horizontal Left /Right
- ALL Aluminum Coil
- Electric Heaters with polarized plug connections (sold as accessory)
- R-410A Thermal Expansion Valve
- ECM Motor (**3.0 – 5 Ton Models**)
- Low Voltage Pigtail Connections

- Draw Through Design
- Horizontal Drain pan
- Single Color
- Fused 24V Power
- **5 year warranty**
- **Optional extended warranty available**

Important: *Condensate management kit is required for all 5 ton air handler models installed in downflow applications.*

About Trane and American Standard Heating and Air Conditioning

Trane and American Standard create comfortable, energy efficient indoor environments for residential applications. For more information, please visit www.trane.com or www.americanstandardair.com.



The manufacturer has a policy of continuous data improvement and it reserves the right to change design and specifications without notice. We are committed to using environmentally conscious print practices.